

NV-2.1 Karbon grafit, utisnut u rotirajući prsten

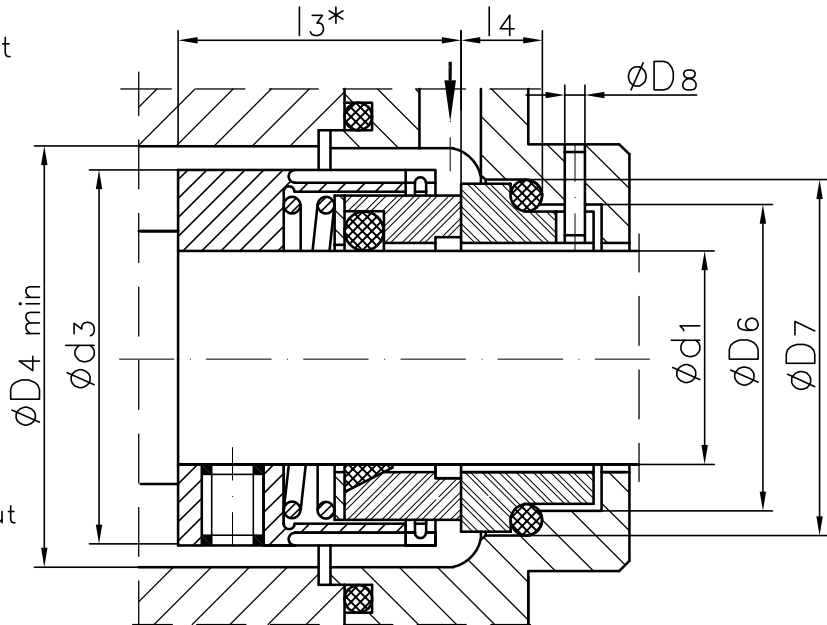

NV-2.2 karbid silicijuma, utisnut u rotirajući prsten

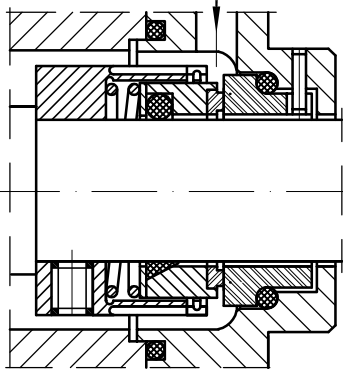
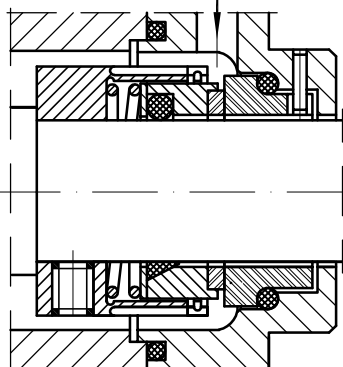

* Dimenzija je data u radnom stanju

NV-2.3 Karbid volframa, ulemeljen u rotirajući prsten

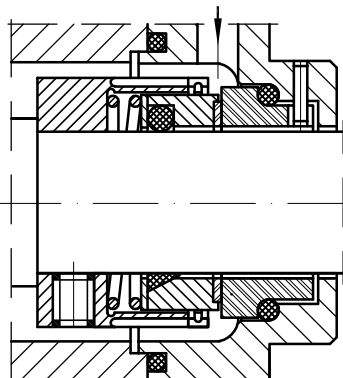

d ₁	d ₃	D ₄	D ₆	D ₇	D ₈	l ₃ *	l ₄
16	30	32	23	27	3	25	10
18	32	34	27	33	3	26	11,5
20	34	36	29	35	3	26	11,5
22	36	38	31	37	3	26	11,5
24	38	40	33	39	3	28,5	11,5
25	39	41	34	40	3	28,5	11,5
28	42	44	37	43	3	31	11,5
30	44	46	39	45	3	31	11,5
32	46	48	42	48	3	31	11,5
33	47	49	42	48	3	31	11,5
35	49	51	44	50	3	31	11,5
38	54	58	49	56	4	31	14
40	56	60	51	58	4	31	14
43	59	63	54	61	4	31	14
45	61	65	56	63	4	31	14
48	64	68	59	66	4	31	14
50	66	70	62	70	4	32,5	15
53	69	73	65	73	4	32,5	15
55	71	75	67	75	4	32,5	15
58	78	83	70	78	4	37,5	15
60	80	85	72	80	4	37,5	15
63	83	88	75	83	4	37,5	15
65	85	90	77	85	4	37,5	15
68	88	93	81	90	4	37,5	15
70	90	95	83	92	4	43	17
75	99	104	88	97	4	43	17
80	104	109	95	105	4	43	17
85	109	114	100	110	4	43	17
90	114	119	105	115	4	48	17
95	119	124	110	120	4	48	17
100	124	129	115	125	4	48	17

Nepokretni prstenovi

S1

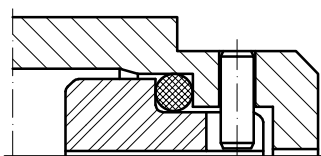

S8

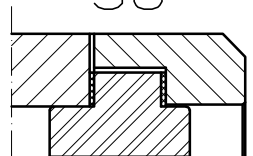

S2

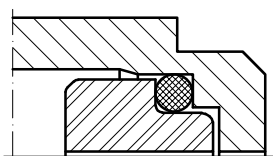

S10

